

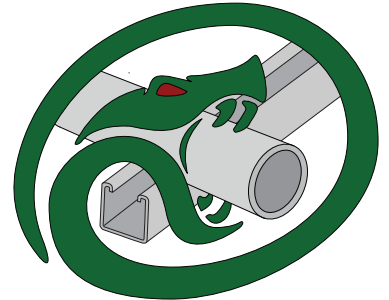

STRUT SERPENT®



Supports Pipe and Tube.

- Electrical and Mechanical Applications.
- Very Clean Appearance After the Assembly is Complete.
- Easy Relocation of Conduit, Pipe, or Tube Prior to Final Alignment.
- Secure the Conduit, Pipe, or Tube Above and/or Below the Strut.
- Perfect for Trapeze Applications.
- A significant reduction of 60% in labor costs to install.
- Worm Gear fastening method that ensures the proper torque-tension.
- Directly Installs to Any Industry Standard Strut Profile.

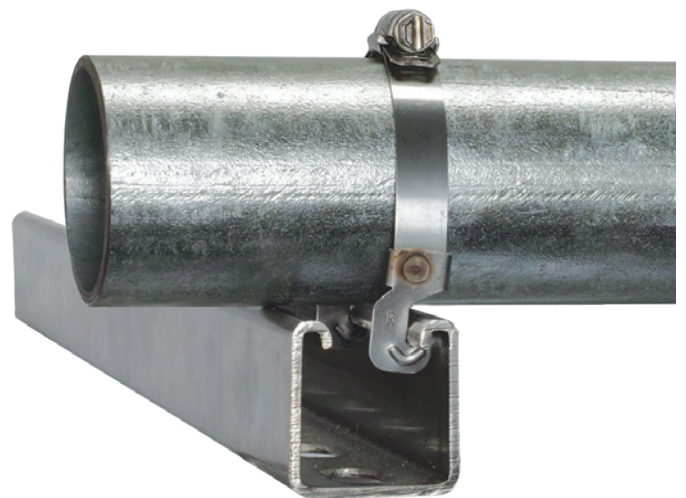

Patented

ZSIINC.COM | 800-323-7053

ZSi & Wesanco are part of the Ideal Tridon Group. Learn more at idealtridongroup.com



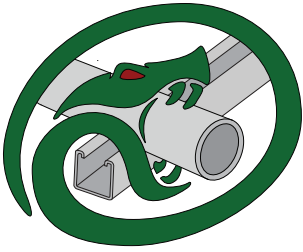

The Simplicity of the Strut Serpent!

Worm Gear Strut Clamp



Part Number	Size	Outside Diameter	Conduit	Stainless Steel Material
SSEMT050	1/2" (13mm)	0.706 (18mm)	Electrical Metallic Tubing (EMT)	Type 301
SSEMT075	3/4" (19mm)	0.922 (23mm)		
SSEMT100	1" (25mm)	1.163 (30mm)		
SSEMT125	1-1/4" (32mm)	1.510 (38mm)		
SSEMT150	1-1/2" (38mm)	1.740 (44mm)		
SSEMT200	2" (51mm)	2.197 (56mm)		
SSGRC050	1/2" (13mm)	0.840 (21mm)	Galvanized Rigid Steel Conduit (GRC)	Type 301
SSGRC075	3/4" (19mm)	1.050 (27mm)		
SSGRC100	1" (25mm)	1.315 (33mm)		
SSGRC125	1-1/4" (32mm)	1.660 (42mm)		
SSGRC150	1-1/2" (38mm)	1.900 (48mm)		
SSGRC200	2" (51mm)	2.375 (60mm)		

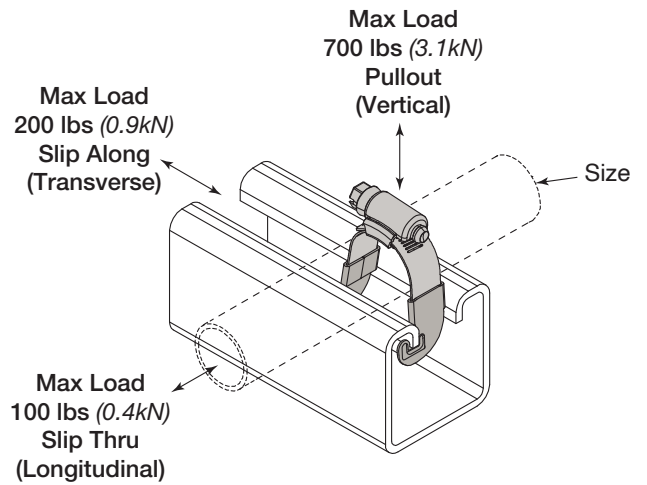

Strut Serpent® – New Installations

Step 1: Place Strut Serpent over pipe and into channel

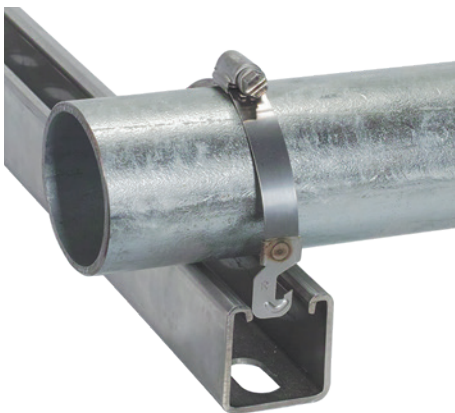

Step 2: Hook Teeth onto channel In-turned edges and Tighten with a wrench

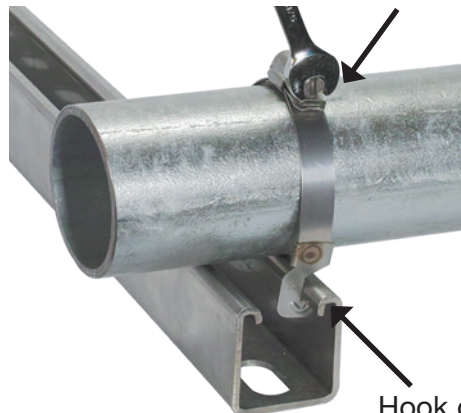

Step 3: Completed. Simple!

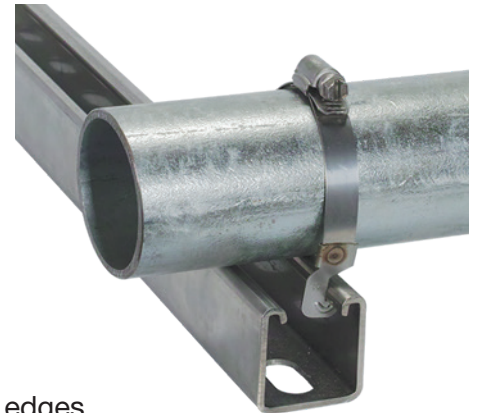

ZSIINC.COM | 800-323-7053

ZSi & Wesanco are part of the Ideal Tridon Group. Learn more at idealtridongroup.com

© Copyright 2024 Ideal Tridon Group / Printed & Designed in the USA / 03-24

